

STELLA

SK100

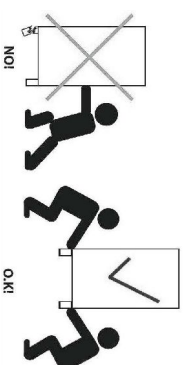
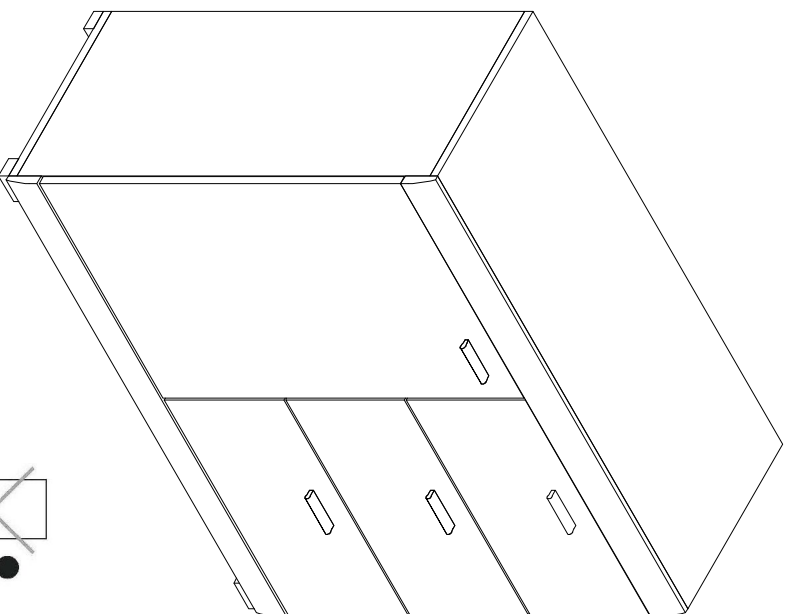

31.8.2018

- D** Montageanleitung
- FR** Notice de montage
- NL** Handleiding voor de montage
- CZ** Montážní návod
- HU** Szerelési útmutató
- TR** Montaj talimatı
- GB** Assembly Instructions
- IT** Istruzioni di montaggio
- PL** Instrukcja montażu
- SK** Návod na montáž
- RO** Instrucțiunile de montaj
- RU** Инструкции по монтажу

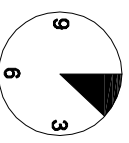
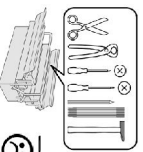

20 min.

1

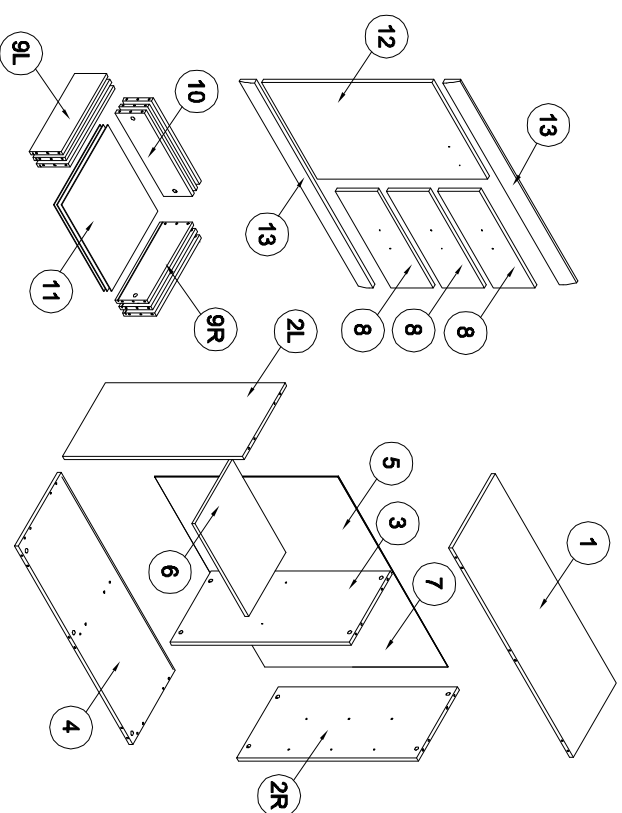

RPS X3 8x32	E1 X18 3.5x13	M1 X4	K6 X8 4x27 6.3x13	PC X2 X30	E X4 4x13	ZC X5 3x20	J X18 4x20	Z X4
A X42	B X30	RC X2	H X4	C X30	Z X30	N X17 3x20	X X8	Y X5

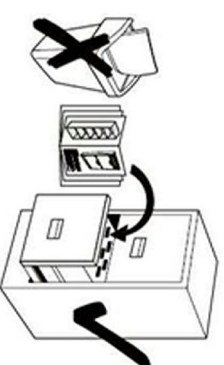
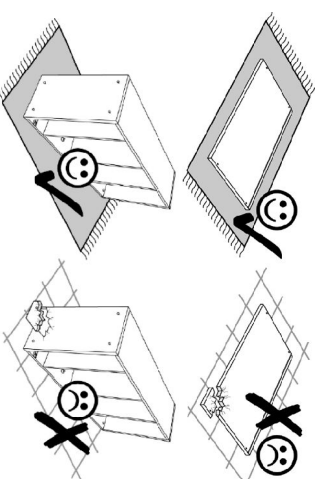

2



Uwaga • Urozognini • Achtung • Attention • Caution • Figyelem
Attenzione • Orgelet • Внимание • Ateñje • Urozognenie • Dikkat

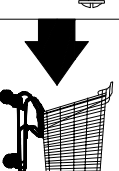
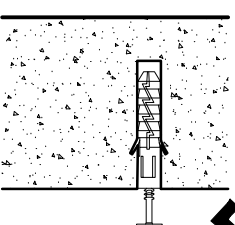
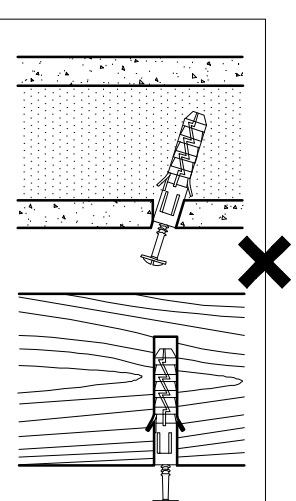
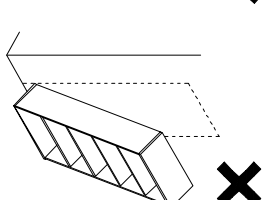
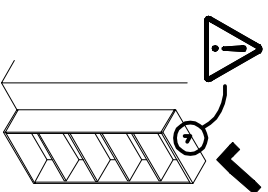
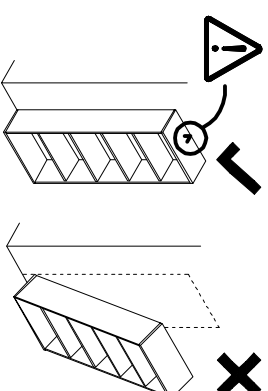
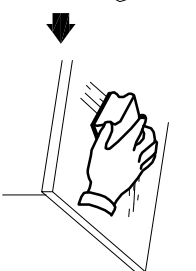
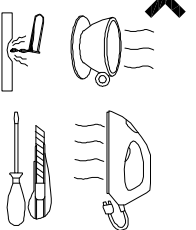
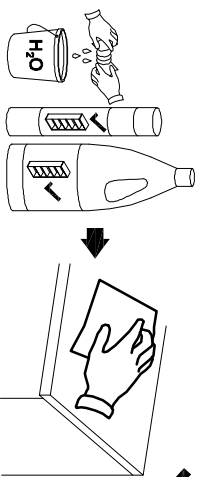
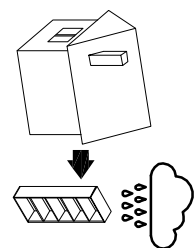
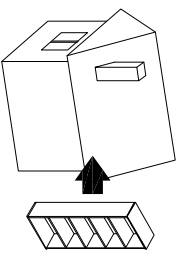

PL	Czyszczenie należy wykonać wyłącznie za pomocą ściereczki lub lekkiego nawilżonego ręcznika. Nie stosować środków czyszczących do szorowania.
CZ	Čistění je nutné vykonávat výhradně pomocí utěrky nebo lehkce navlhčeného ručníku. Nepoužívejte čisticí prostředky obsahující abrazivní částice.
DE	Bitte nur mit einem Staubtuch oder leicht feuchtem Lappen reinigen. Keine scheuernden Putzmittel verwenden.
GB	Please only clean with a duster or damp cloth. Do not use any abrasive cleaners.
FR	Le nettoyage se fait uniquement à l'aide d'un torchon ou d'une serviette légèrement mouillée.
NL	Reinig alleen met een stofdoek of een lichtjes vochtige doek. Gebruik geen schurende poetsmiddelen.
IT	Pulire esclusivamente con un panno o un asciugamano umido.
HU	A tisztítás kizárólag törölközővel vagy enyhén nedvesített törölközővel véggezhető. Súroló hatású tisztítószereket nem szabad használni.
RU	Чистайте от пыли тряпкой или слегка влажной ветошью. Не допускаются применение чистящих средств, не пред-назначенных для ухода за мебелью.
RO	Curăţarea trebuie efectuată numai cu o cârpă sau cu un prosop sau cu un prosop ușor umezit. Nu utilizaţi agenţi de curăţare abrazivi.
SK	Čistenie je nutné vykonať výhradne pomocou utierky alebo ľahko zvlhnutým ručníkom. Nepoužívajte čistiace prostriedky obsahujúci abrazívni častice.
TR	Lütfen sadece bir toz bezilye veya hafif nemli yumuşak bir bezle siliniz. Aşındırıcı temizlik malzemeleri kullanmayınız.

PL	Mocowanie do ścian jest jednocześnie zabezpieczeniem przed przewróceniem - koniecznie zamontować! Do niektórych rodzajów ścian koniecznie zastosować specjalne kołki mocujące.
CZ	Montáž na stěnu slouží jako ochrana proti převrnutí - bezpodmínečně umístěte! U některých typů stěn může být zapotřebí speciální hmoždinky!
DE	Wandbefestigung dient als Kippschutz - unbedingt anbringen! bei einigen Wandtypen kann ein Spezialdübel erforderlich sein!
GB	The wall fastening serves to prevent tipping - be absolutely sure to mount it! For certain wall types, a special wall plug may be necessary!
FR	La fixation murale sert de protection contre le basculement - à installer impérativement! Pour certains types de murs il faut des chevilles spéciales!
NL	Bevestiging aan de muur dient als kantelbescherming - zeker en vast bevestigen! Bij enkele muurtypes is een speciale plug misschien vereist!
IT	Il fissaggio alla parete serve da protezione anti-ribaltamento-attaccarla assolutamente! Per alcune strutture di parete può essere necessario un tassello speciale!
HU	A terméket a falhoz kell rögzíteni, külsőben az felborulhat! Egyes falípusoknál speciális tipit kell használni!
RU	Обязательно установите крепление на стене во избежание опрокидывания! Для некоторых типов стен может потребо- ваться специальный дюбель!
RO	Sistemul de fixare la perete serve ca protecţie la răsturnare - de montat obligatoriu! Pentru unele tipuri de pereţi este posibil să fie necesar un diblu special!
SK	Upevanie na stenu slúži ako ochrana proti prevráteniu - bezpodmienečne použiť! Pre niektoré dĺhny stien môže byť potrebná špeciálna hmoždinka!
TR	Duvardaki sabitleme, devrilmeye karşı bir emniyet tedbidir ve mutlaka monte edilmelidir! Bazı duvar tiplerinde bunun için özel bir dübel gereklili olabilir!

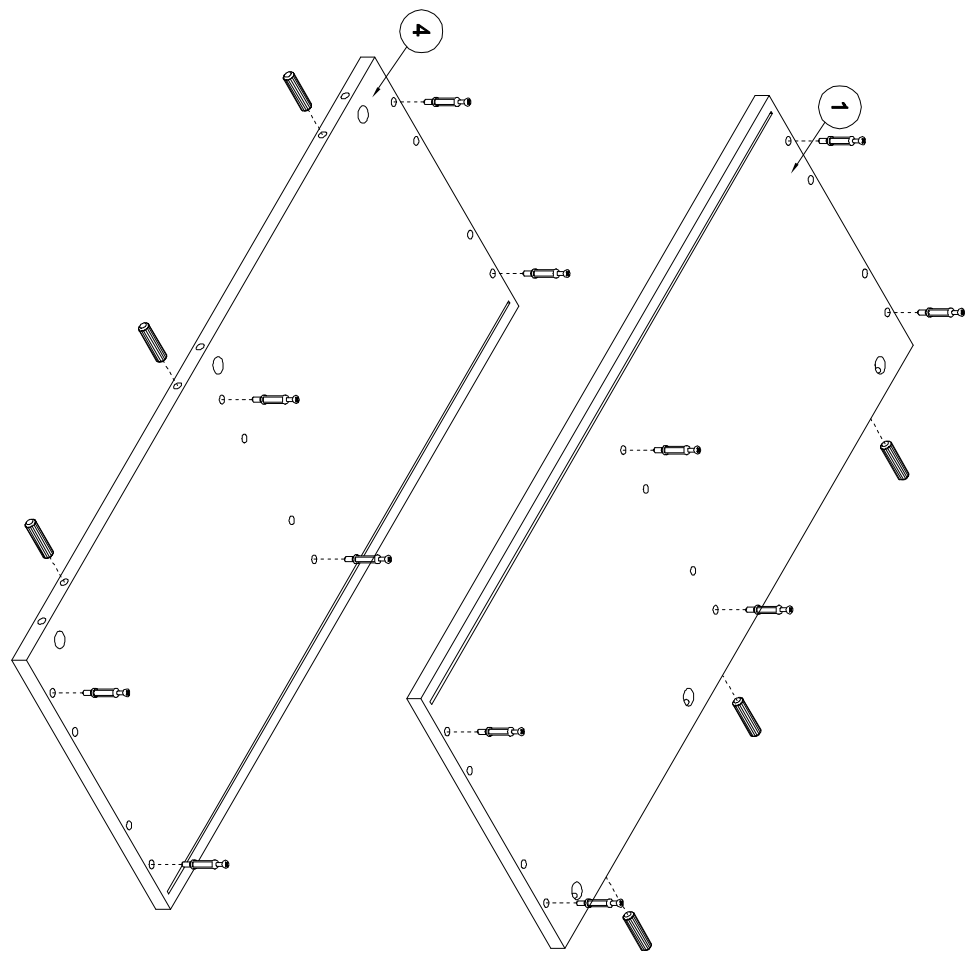
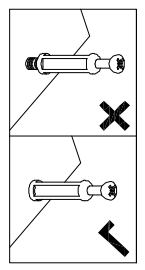

- A**
Øx32
x6
- B**
x12

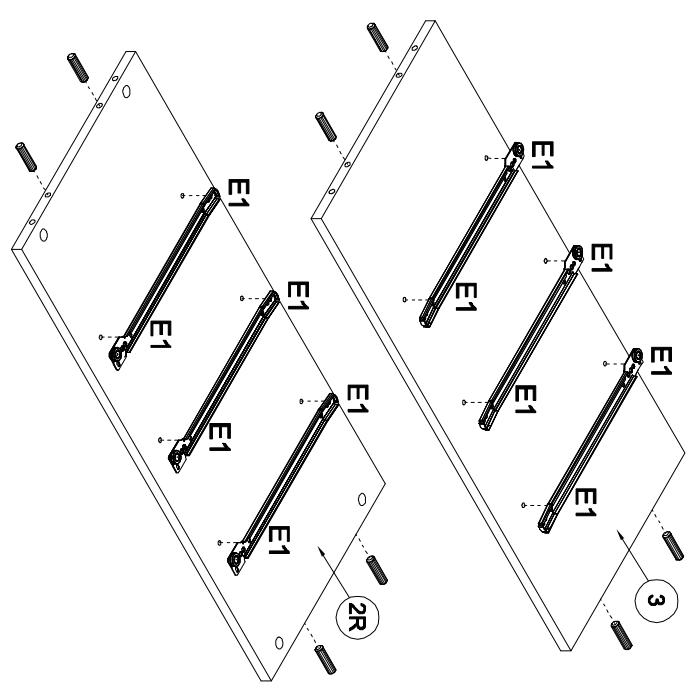
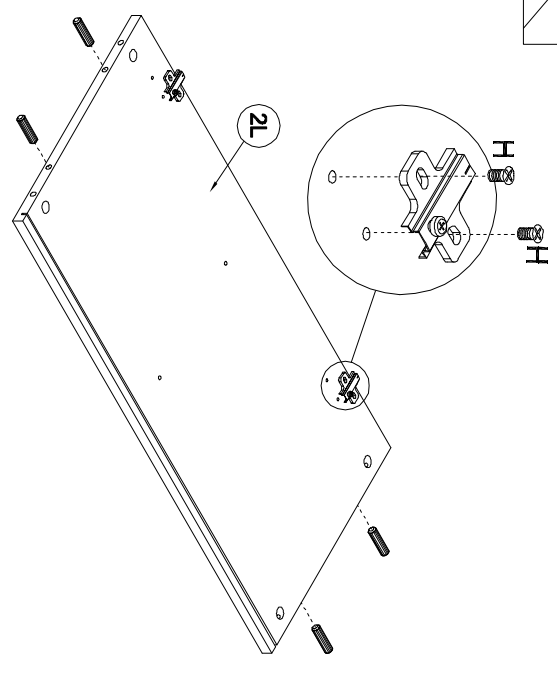
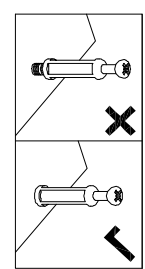

- RPS**
x3
- E1**
3,5x13
x3
- A**
Øx32
x18
- RC**
x12
- H**
6,3x13
x2
- H**
x4

5

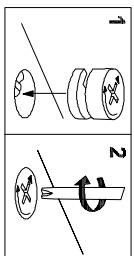
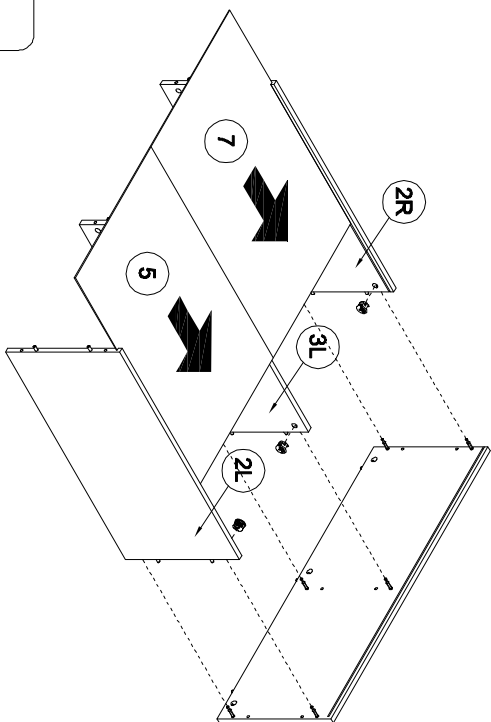
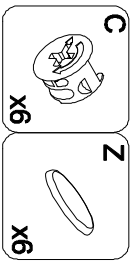

6

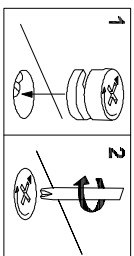
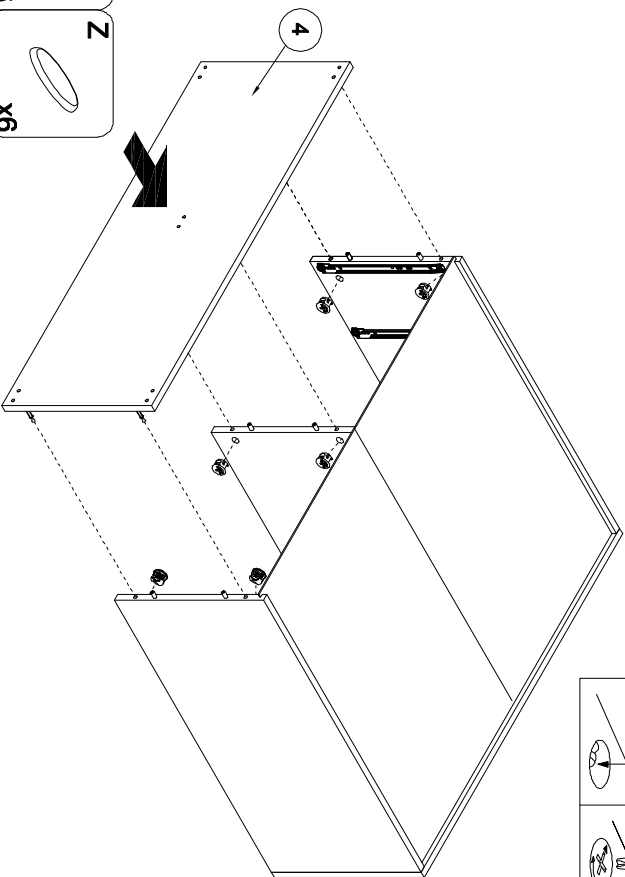
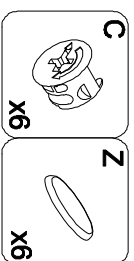

1

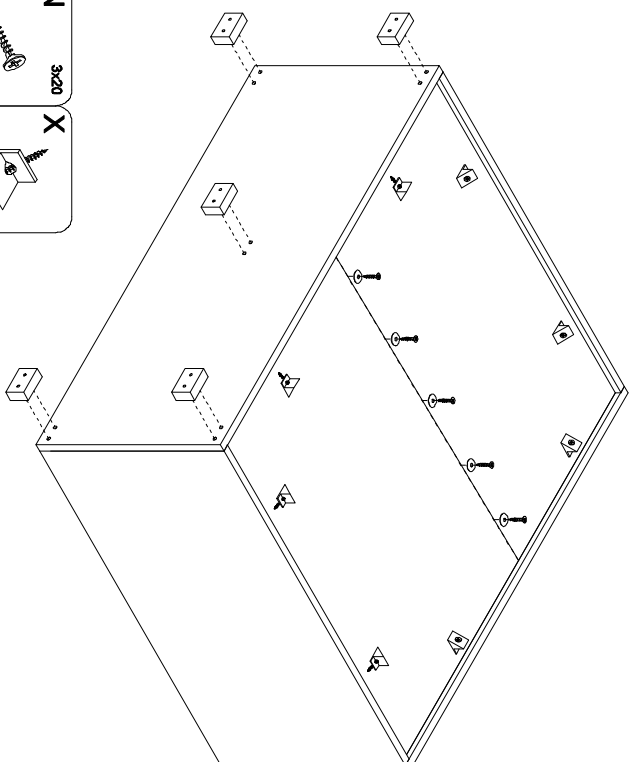
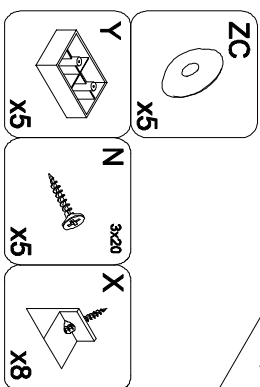

8

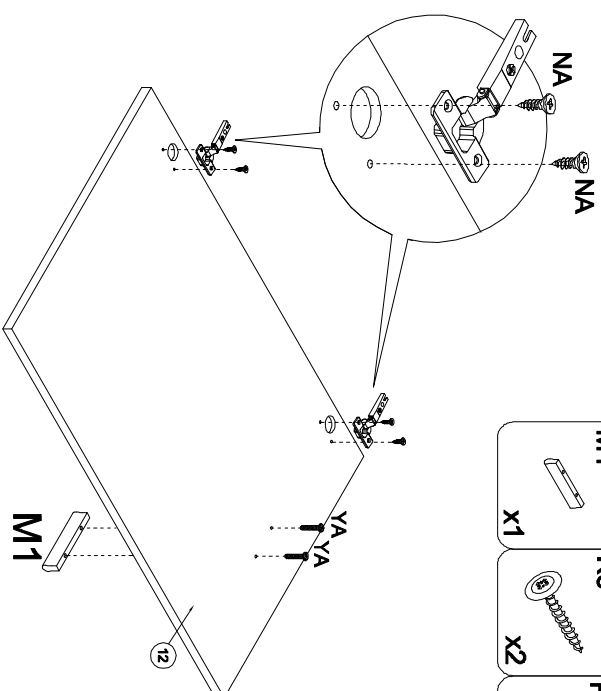
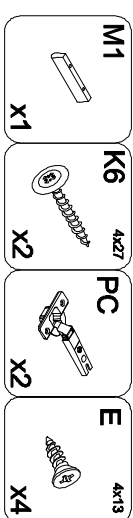

9

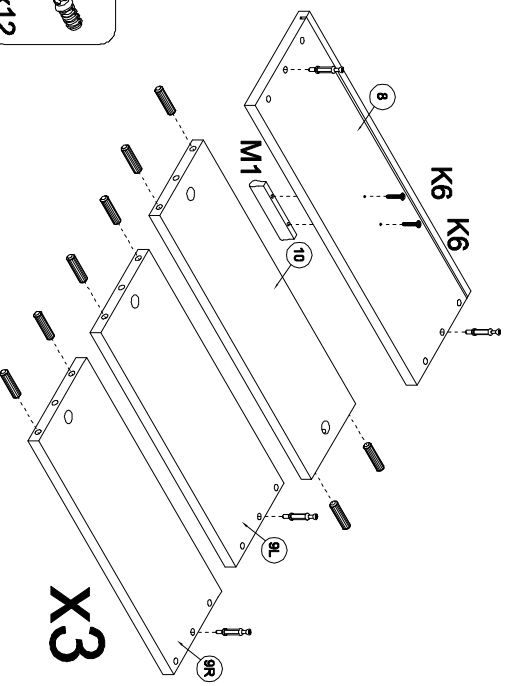

- | | |
|-------------------------|-----------------|
| A
8x32
X24 | B
X12 |
| K6
4x27
X6 | M1
X3 |

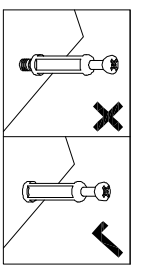

- | | |
|----------------|----------------|
| C
X6 | Z
X6 |
|----------------|----------------|

11

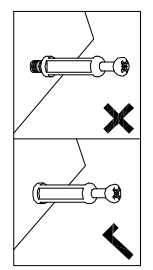
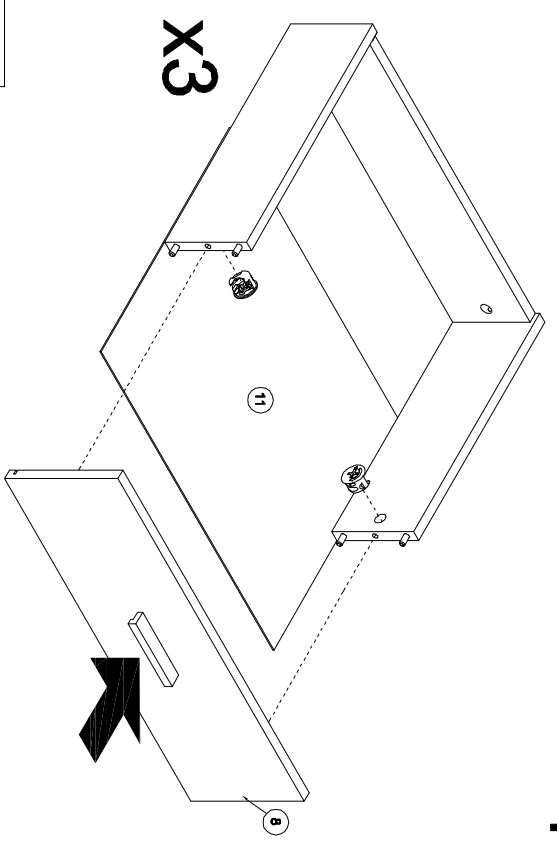

- | | |
|----------------|----------------|
| C
X6 | Z
X6 |
|----------------|----------------|

10

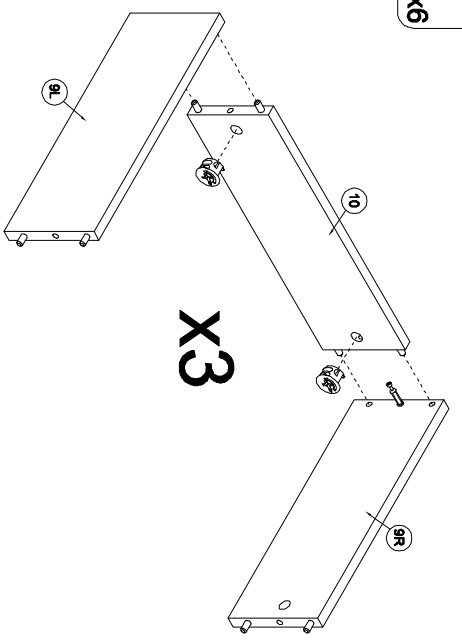

12

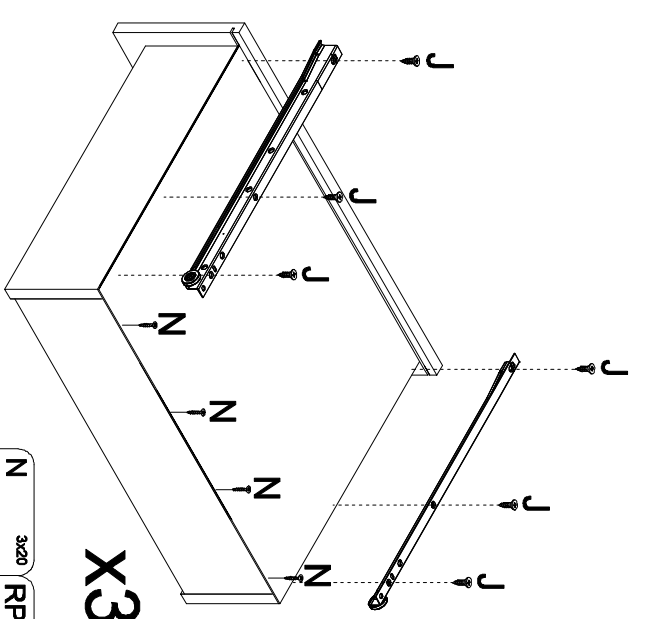

- | | | |
|-------------------------|------------------|-------------------------|
| N
3x20
X12 | RPS
X3 | J
4x20
X18 |
|-------------------------|------------------|-------------------------|

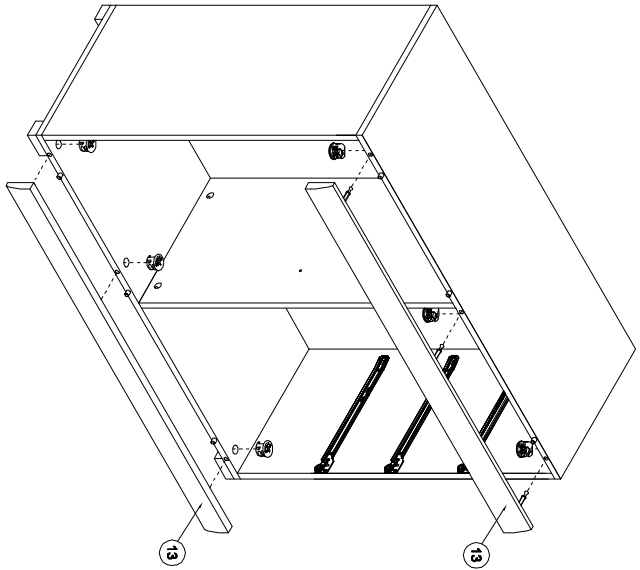
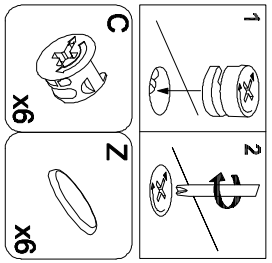

13

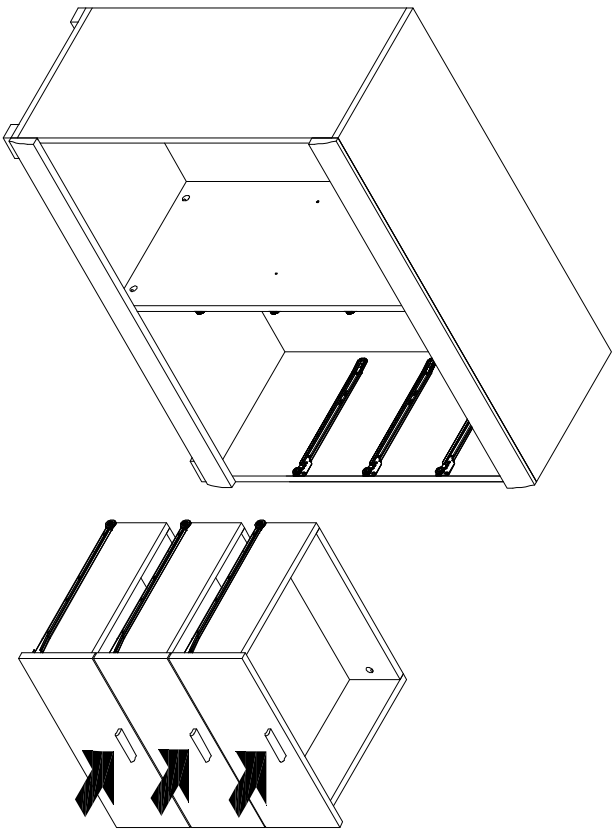

14

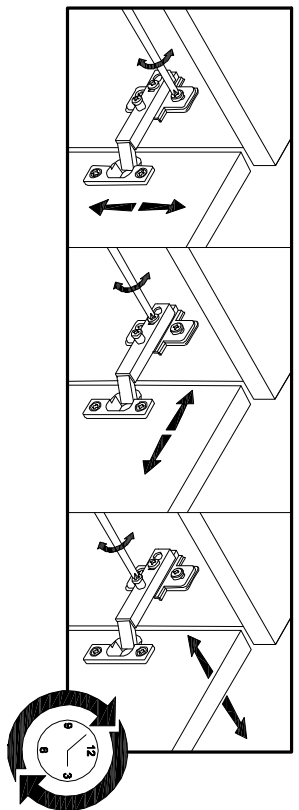

15

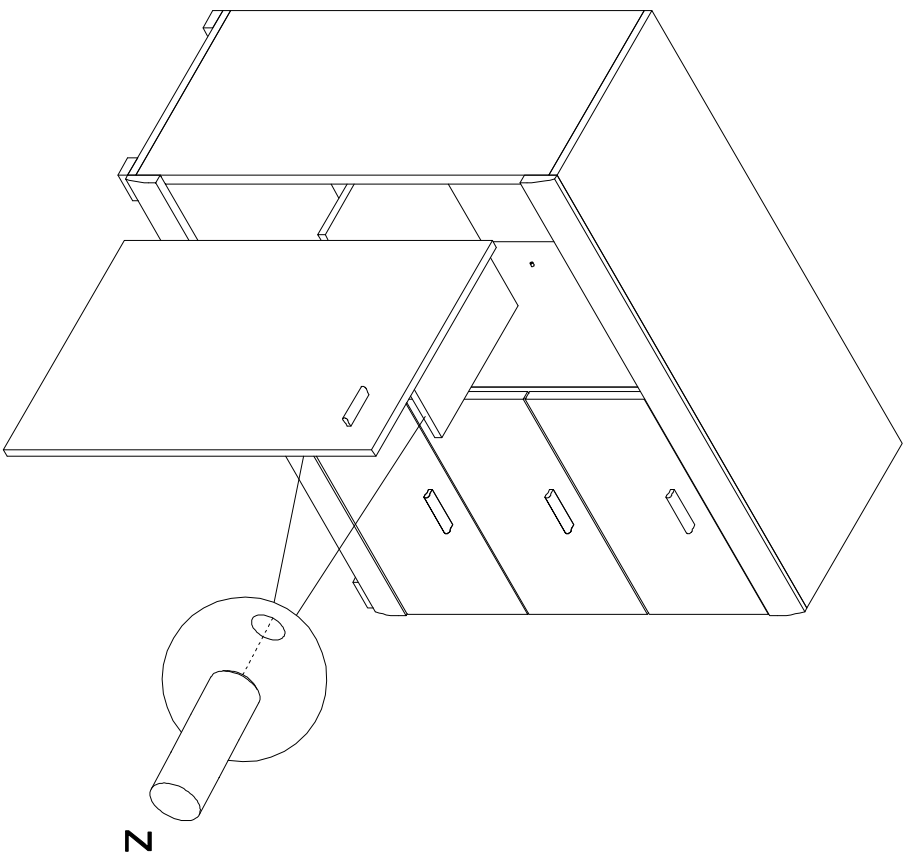

Z